



**PowerBlock**

*Ignition  
Systems*

---

**ASSEMBLY INSTRUCTIONS FOR BOSCH AND MOTOPLAT REPLACEMENT**

E\_D\_HKZ\_05

(c)07\_2010

5. Februar 2015

## ASSEMBLY INSTRUCTIONS FOR BOSCH AND MOTOPLAT REPLACEMENT :

The Power Block ignition system is far superior to conventional ignitions that usually achieve double the ignition tension, double the ignition energy, as well as double the spark duration. The adjustment of the ignition timing is worked out by a digital High Speed Microprocessor, with 16bit resolution (65536 points) for each single revolution. The Signal conditioning as well as the ignition amps control are also carried out digitally, to achieve maximum efficiency with a minimum loss. The necessary D-Well time of the ignition coils is worked out digitally to achieve maximum energy saving. The output requirements of the ignition system (module + ignition coil) is approximately 17W with 1000 RPM and approximately 67W with 5000 RPM.

**The full performance of our Power Block ignitions is only possible with SILENT HEKTIK ignition coils, because the ignition curves for the relevant ignition energy as well as tensions are tuned and the D-Well timing on the technical details of the coils are cut.**

**With unsuitable or inadequate ignition coils, not only does the guarantee expire, there will also be bad throttle response; bad coldstart or perhaps missfire.**

## SAFETY PRECAUTIONS AND NOTICES

Caution High Voltage! Mortal danger !

To avoid injury or destruction of the electronic, attention should be paid to the following when working on vehicles with full electronic digital high energy ignition systems:

- Read the assembly instructions carefully and completely and follow the instructions. Display warning labels in a good visible place!
- To install the modules, specialized knowledge and tools are required.
- People with a Pacemaker should not carry out work on electronic ignition systems.
- To synchronize the carburettor **never** pull out a spark plug.
- Do not touch or remove ignition cable when the ignition is on.
- Only connect or disconnect the cable from the ignition system when the ignition is turned off.
- Always connect the high tension cable to ground (mass) with or without the spark plugs after removal.
- Checking the function of the high tension part with a spark to the ground (mass) leads to damage.
- Washing the engine or vehicle is only to be carried out when the ignition is turned off and the engine is stopped.
- The ignition module should be carefully protected from static tension.
- Separate ignition module from the cable harness when electric welding.
- Faulty alternator regulators (max. tension 15V ) are often the cause of breakdown.
- Jumpstarting with a battery charger is only permitted for 1 minute with max. 15V.
- There is no guarantee for the accuracy of the timing curves with tuned engines; consultation and tuning of the tuner absolutely necessary.
- Guarantee-, replacement or claim for compensation only in reference to the supplied electronic; mistakes and changes in future to be accepted.



### Ajustment of the ignition timing:

The sixteen timingcurves can be chosen by the right switch  
The curves are shown on page\_5

### Ajustment of the rev.-limitter:

The limitter can be sett by the left switch:

0 = 6000 rpm	1 = 6333 rpm	2 = 6666 rpm
3 = 7000 rpm	4 = 7333 rpm	5 = 7666 rpm
6 = 8000 rpm	7 = 8333 rpm	8 = 8666 rpm
9 = 9000 rpm	A = 9333 rpm	B = 9666 rpm
C = 10000 rpm	D = 10333 rpm	E = 10666 rpm
F = 11000 rpm		

factory setting = 8



## ASSEMBLY AND CONNECTIONS:

Our digital ignition box is mounted on the original place with the connections underneath and replaces both Kokusan ignition boxes. For securing you can use for example an O ring.

The two original sensor plugs as well as the two cable harnesses are plugged together into the Power ignition box.

Take care that the sensor with the ignition coil for the horizontal cylinder is plugged into the LEFT connection of the digital ignition box and the sensor with the ignition coil for the vertical cylinder is plugged into the RIGHT connection of the digital ignition box.

The ignition coils are assembled in place of the original ignition coils. The holders are suitable.

The Power ignition cable as well as the Plus and Minus cable should be connected to the ignition coils before you assemble these, because after the assembly it will be very tight under the coils. You can use the 6.3mm FastOn for the 4.8mm connector of the Minus connection or better reduce the connector of the ignition coil with a metal shears sideways to 4.8mm.

To avoid faults, take care when laying the cables that the biggest possible distance is between the sensor and ignition coils supplies. Particularly the ignition coil, should be as far as possible from the Pickup cable.

The engine housing must have a good ground (mass) connection to the battery -> Battery ground (mass) cable on gearbox housing!

With an optimal working ignition system the amount of the spark plug gap is 0.5 - 0.6mm.

Please use radio suppressed ignition coil connectors with a resistance of minimum 5k and / or resistance ignition cable -> otherwise faulty function.

The operation of this full electronic device will only be perfect with a good radio suppression.

To avoid short circuit with Twinspark applications, be careful that there is enough distance from the spark plug socket to the cooling fin. Protect all plug connectors from damp and humidity with a special grease.

During motor vibration, soldered crimp connectors lead to hairline cracks and breakdown.

Faulty kill switches on the handlebars and the sidestands are often a source of trouble.

Only ignition coils with a primary resistance of minimum 30Ohm should be used -> Guaranteed loss when not used!!!

When the engine is stopped the amps power of the ignition module will be switched off after a few seconds; Careful when carrying out work.

An electronic rev counter is connected as before, on the ignition coil clip KL1.

On the TEC & Jap ignition coils is black the plus

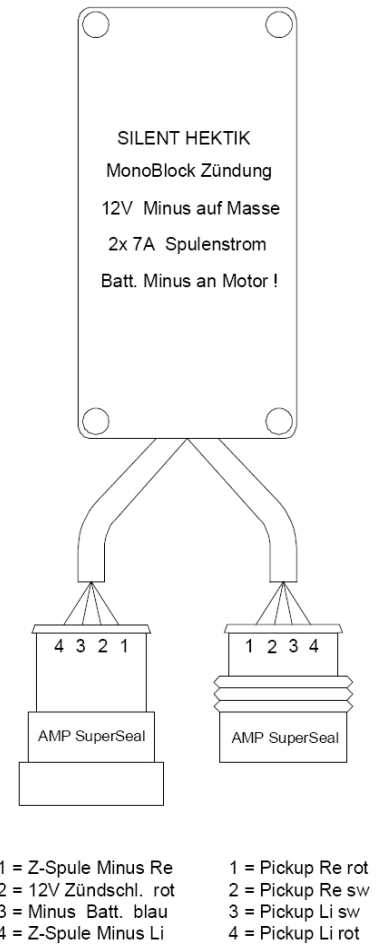

## ADJUSTMENTS:

For basic adjustment of all Singlespark ignitions (normal ignitions) the following curves come into consideration:

<b>500er-600er</b>	<b>Pantah</b>	<b>8° - 9° BTDC</b>	<b>Nr. 9</b>
<b>650er-750er</b>	<b>Pantah</b>	<b>7° - 8° BTDC</b>	<b>Nr. 8</b>
<b>750er</b>	<b>KöWe</b>	<b>5° - 6° BTDC</b>	<b>Nr. F</b>
<b>900er</b>	<b>KöWe</b>	<b>5° - 6° BTDC</b>	<b>Nr. E</b>

With knocking because of bad petrol or with side car combination, use the next flatter timing-curve form.

To tune a Twinspark ignition, a lot of experience and a feel for it is necessary. It is better if you stick with the tuner's instructions. With independent tuning use the following adjustments first of all and try the next lines in driving:

<b>compression-ratio under</b>	<b>1:10</b>	<b>6° BTDC</b>	<b>Nr 5</b>
<b>compression-ratio over</b>	<b>1:10</b>	<b>6° BTDC</b>	<b>Nr 4</b>

The tuning is complete when you have the maximum driveability with the smoothest running motor.

With compression over 1:10 you have to carry out an increased radio suppression with suppressed coil plugs, spark plug sockets and ignition spark plugs : e.g. BPR6HVX There should also be the biggest possible distance from the box to the coils.



Doppelfunken-Zündspule optimal am Rahmen montiert

**ASSEMBLY AND ADJUSTMENT OF THE PICKUPS WITH MOTOPLAT- REPLACEMENT:**

As CDI replacement the baseplate with the Pickups as well as the rotor are mounted in place of the ignition generator with a distance of 0.2 - 0.3mm. As a rough adjustment the left over edge of the rotor should be approximately at the middle of the Pickup centre, in a clockwise direction. The mechanical basic adjustment refers to the static ignition timing of 6° BTDC.

By turning the baseplate with the Pickups the static ignition timing of both cylinders by means of a stroboskop-light will be adjusted to approx. 1200 RPM.



**ASSEMBLY AND ADJUSTMENT OF THE PICKUPS WITH BOSCH REPLACEMENT:**

The Pickup`s distance is adjusted to 0.2 - 0.3mm with the Ducati tool or a SH tool. Instead of the tools you can also use the dismantled ignition rotor on a central wave to adjust the distance: see photo on the right.

The static ignition timing is in the turning direction of the left over edge of the ignition rotor. For Singlespark this edge should be in the middle of the Pickup`s centre with 8° BTDC and for Twinspark (double ignition) with 6° BTDC.

For the basic adjustment of the Pickups you can use the Ducati tool or the SH tool. With the SH tool you draw near the 5mm bulge of the tool. With the Ducati tool the round Pickup centre should lie in the middle of the bulge.

After successful assembly and adjustment the static ignition timing of both cylinders approx. 1200 RPM with 8° or 6° BTDC, should be checked with a stroboskop-light.

With the SH ignition box, because of tolerance and magnetic interaction, two ignition spark can come through the level of the trigger nose. In this case, the level of the trigger nose should be turned with a machine or straightened with a file. When filing, it is enough if the front nose area is sloped. The back nose area should stay the original 5mm length. The nose length must stay unchanged. For maximum precision with Twinspark ignitions the trigger nose should be turned. On the TEC ignition-coils the plus is black.



**CONNENCTION DIAGRAMM FOR BOSCH - BOXES :**

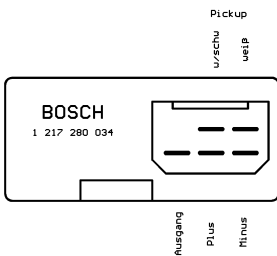

	front cylinder horizontal	back cylinder vertikal	MotoCoil
Bosch-Pickup:	white (+) w-black (-)	white (+) w-black (-)	
SH-Pickup :	red (+) black (-)	red (+) black (-)	
Output :	blue-black	red-black	-> Minus - (Kl 1)
Plus :	red	red	-> Plus + (Kl 15)
Minus :	braun	braun	

**CONNENCTION DIAGRAMM FOR BOSCH & MOTOPLAT REPLACEMENT :**

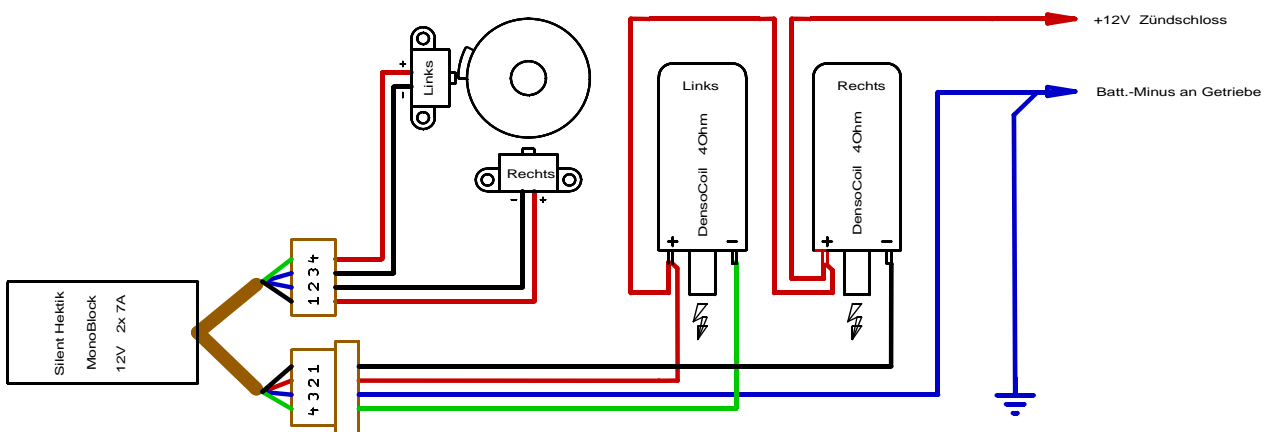

Left output = vertikal = green      Right output = horizontal = black      one plus 12V input is enough

The 16 timing-curves of the **PowerBlock** - ignition from Version KD\_14CK

switch positions:

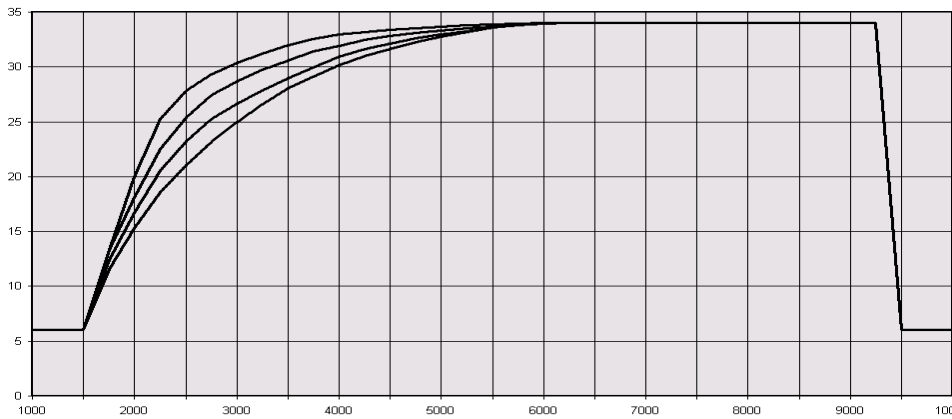

**34° BTDC curves**

Nr.	<b>F</b>	XL
Nr.	<b>E</b>	L
Nr.	<b>D</b>	M
Nr.	<b>C</b>	S

MotoCoil D-Well

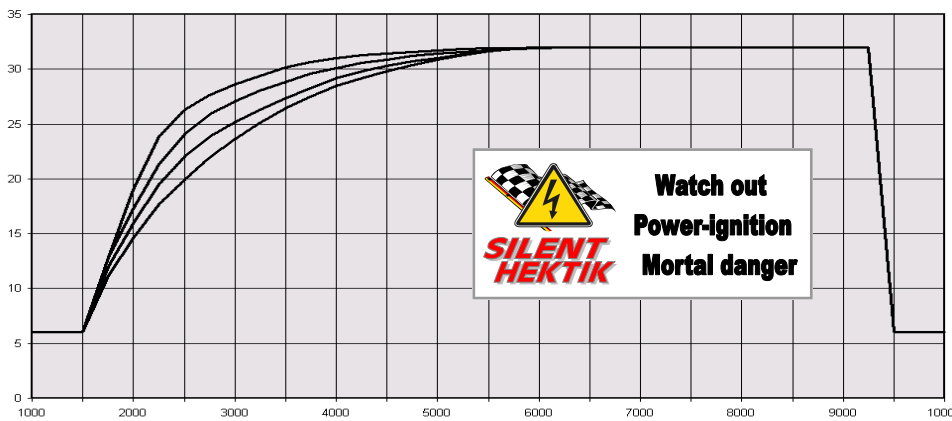

**32° BTDC curves**

Nr.	<b>B</b>	XL
Nr.	<b>A</b>	L
Nr.	<b>9</b>	M
Nr.	<b>8</b>	S

MotoCoil D-Well

factory setting = 8

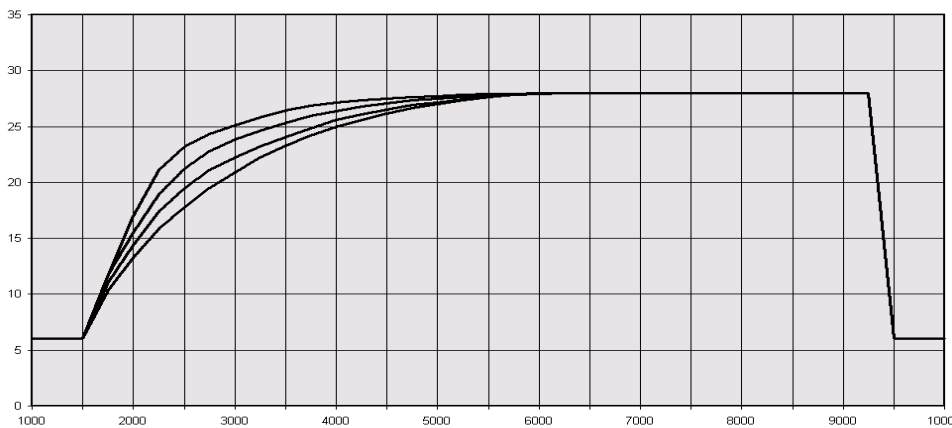

**28° BTDC curves**

Nr.	<b>7</b>	XL
Nr.	<b>6</b>	L
Nr.	<b>5</b>	M
Nr.	<b>4</b>	S

TecCoil D-Well

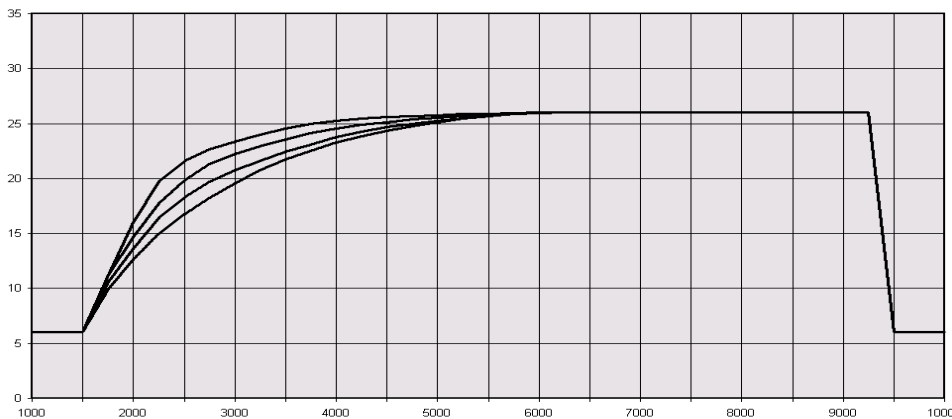

**26° BTDC curves**

Nr.	<b>3</b>	XL
Nr.	<b>2</b>	L
Nr.	<b>1</b>	M
Nr.	<b>0</b>	S

TecCoil D-Well

# SILENT HEKTIK

INJEKTIONS IGNITIONS COILS SPARK-PLUGS REGULATORS TOOLS

... and the power will be with you !



ADRESSE : SILENT HEKTIK  
: HANSASTR. 72B  
: D-59425 UNNA  
: GERMANY  
TEL-NUMBER : +49-2303-257070  
FAX-NUMBER : +49-2303-257071  
HOMEPAGE : WWW.SILENT-HEKTIK.COM  
SHIPPING : WORLDWIDE

